

LEVITO

Art.-Nr.

399 665
399 666
399 667
399 668

980
1795
350
mm

1/10

v0

40-2024

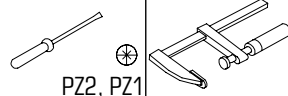
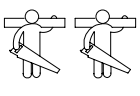

PZ2, PZ1

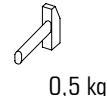

0,5 kg



3m

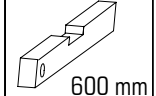

600 mm

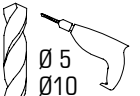

Ø 5
Ø 10



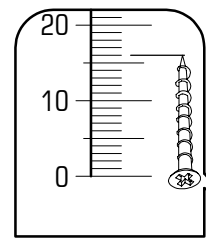
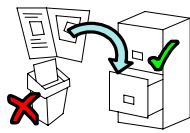
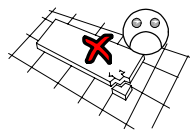
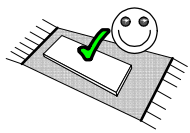
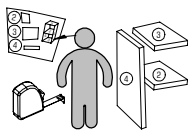
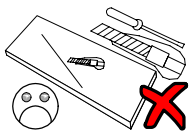
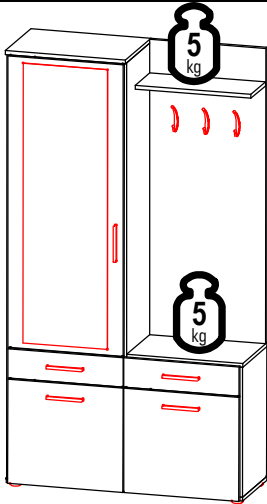
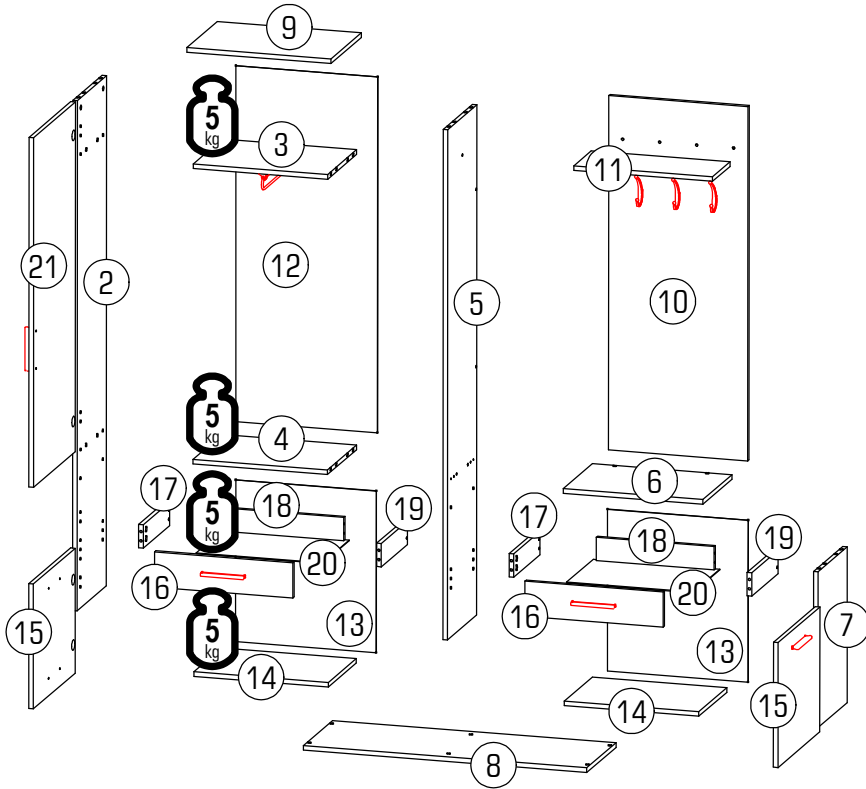
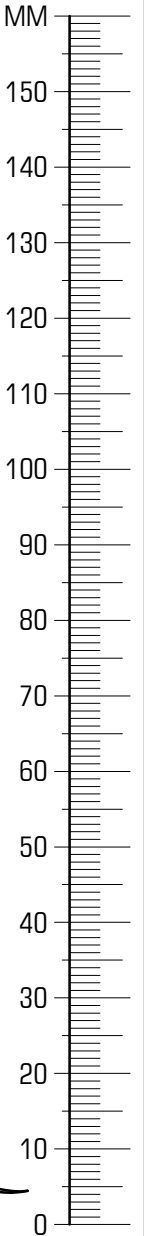



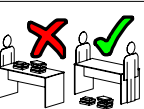
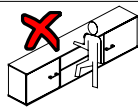
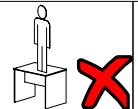
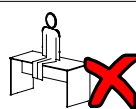
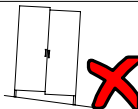
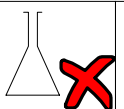

ID	Q	Dimensions	Qty	Ratio
21698	2	1748*333*16	1x	1/2
21699	3	465*332*16	1x	1/2
21700	4	465*332*16	1x	1/2
21701	5	1748*333*16	1x	1/2
21702	6	482*333*16	1x	2/2
21703	7	534*333*16	1x	1/2
21704	8	980*334*16	1x	1/2
21705	9	498*350*16	1x	2/2
21706	10	1214*481*16	1x	2/2
21707	11	480*200*16	1x	2/2
21708	12	1219*490*3	1x	2/2
21709	13	554*486*3	2x	2/2
21710	14	465*320*16	2x	2/2
21711	15	478*428*16	2x	2/2
21712	16	478*120*16	2x	2/2
21713	17	300*80*16	2x	1/2
21714	18	407*80*16	2x	2/2
21715	19	300*80*16	2x	1/2
09103	20	306*437*3	2x	2/2
21716	21	478*1198*16	1x	2/2

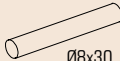

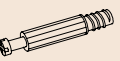
22800,01 A	4	27000,00 B	Ø8x30 16x	22300,00 C	Ø7x50 23x	70013,01 D1	Ø15x13 24x	D2	16x	70021,01 E	24x	21102,00 F	Ø1,6x20 50x	22236,00 G	Ø2,5x16 6x	31103,00 H	1x
22244,01 J	Ø3,5x16 14x	22256,00 K	Ø5,0x70 1x	24101,00 L	Ø10 1x	22243,00 M	Ø3,5x15 28x	22250,00 N	Ø4x25 5x	22430,00 P	Ø4x25 6x	22705,00 Q	Ø6,8x8 8x	24008,00 R	3,0 6x	35101,01 S	8x
36013,02 T	6x	36013,02 U	6x	30080,00 V	Ø44x15 5x	32030,00 W1	L=148 5x	22280,00 W2	Ø4x30 10x	33003,00 X1	L=300 2x	33003,00 X2	L=300 2x	317001,01 Y	L=300 1x	31030,00 Z	3x



2/10 LEVITO



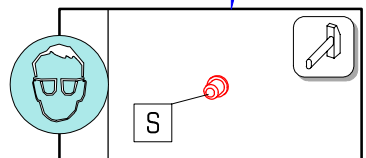
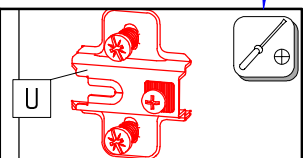
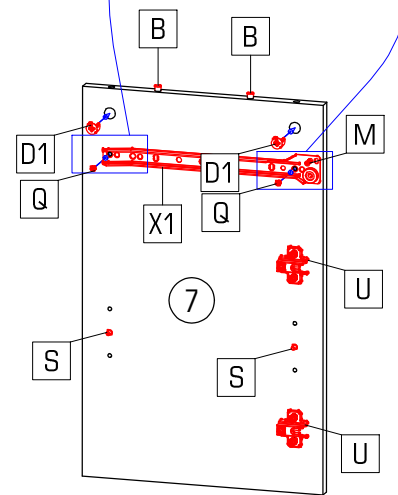
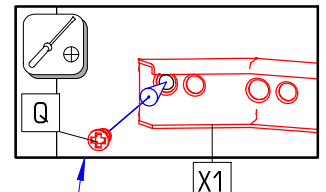
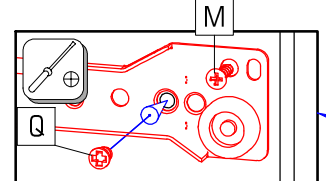
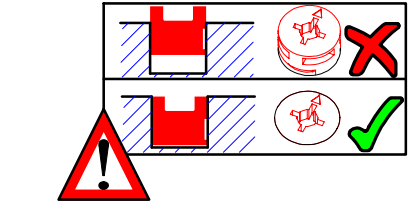
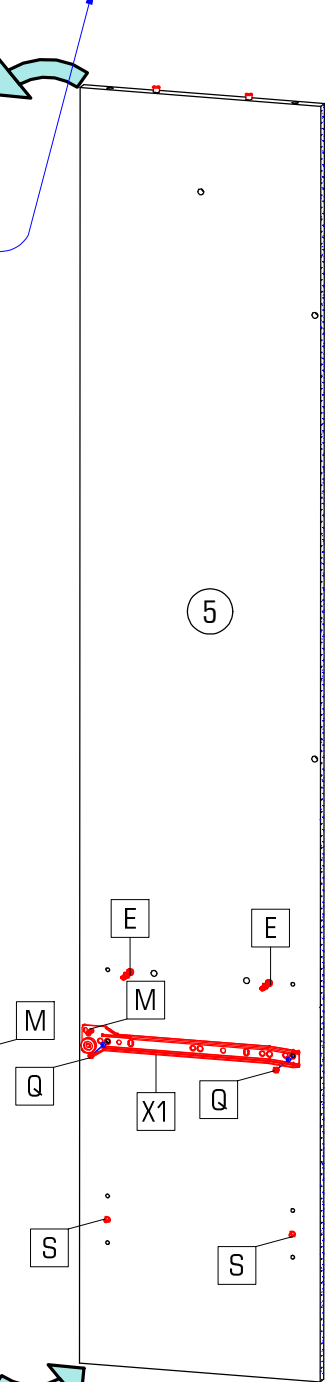
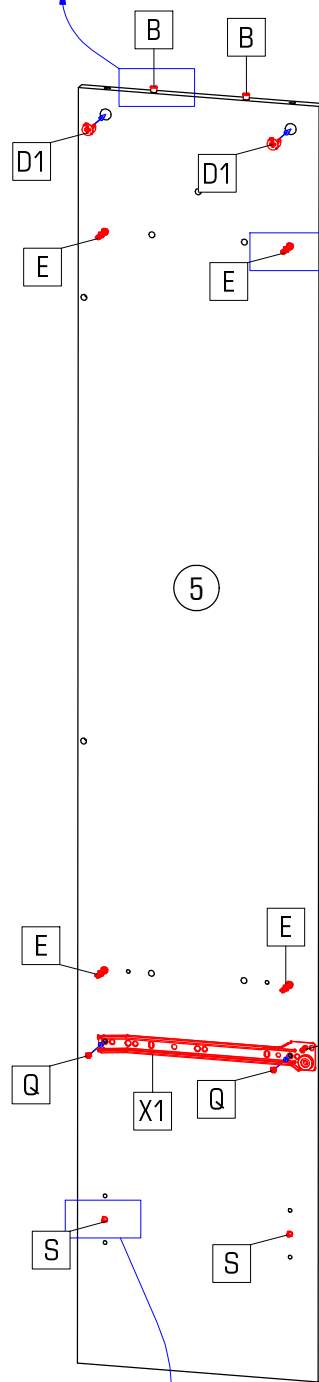
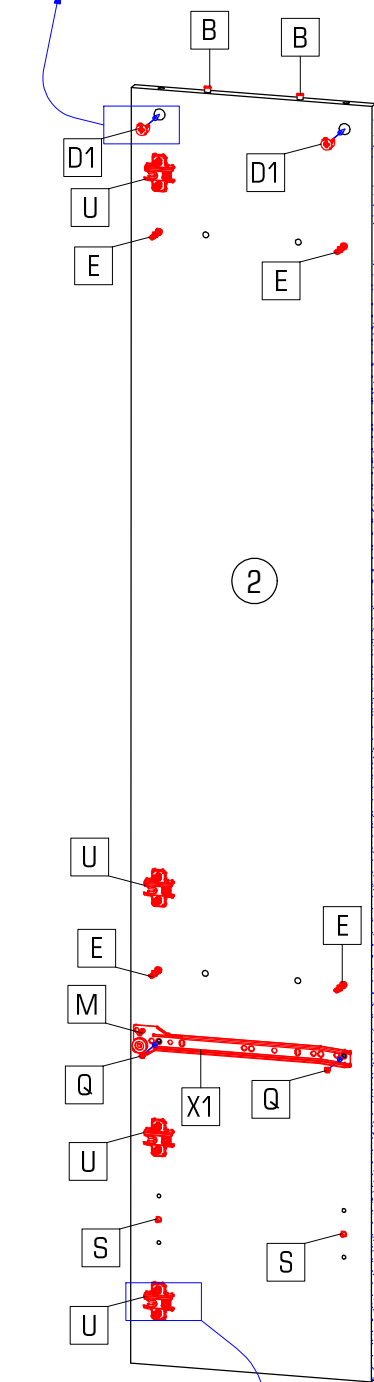
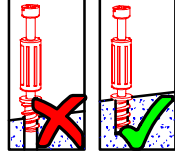
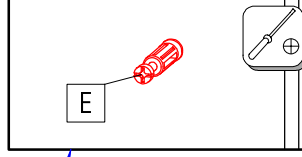
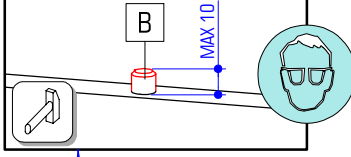
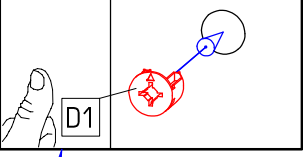
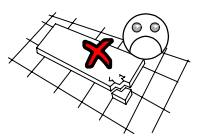
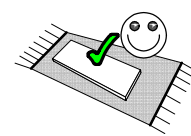
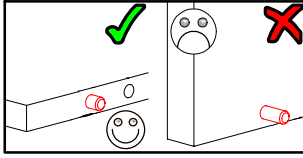
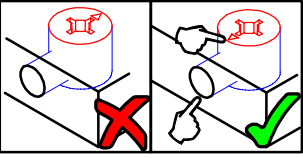

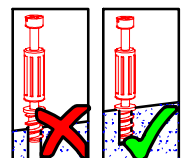
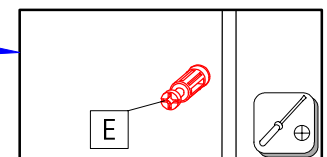
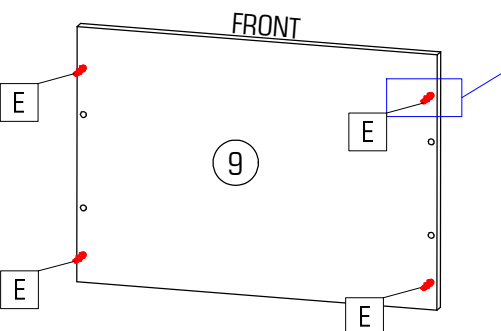
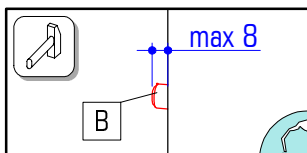
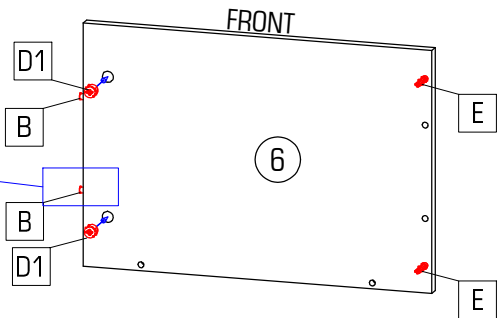
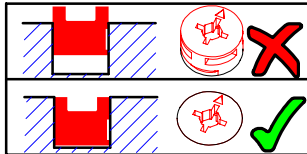
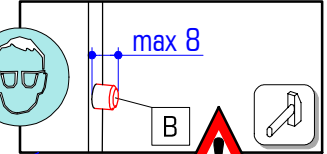
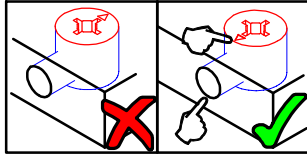
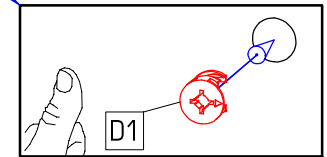
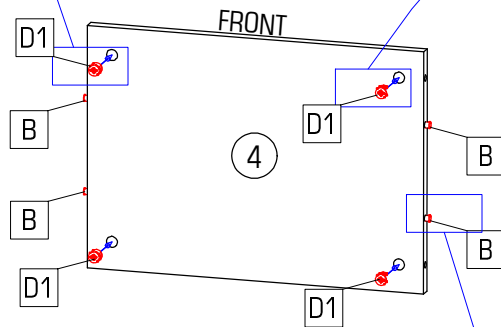
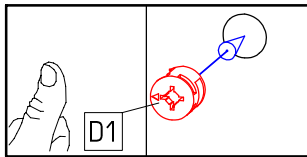
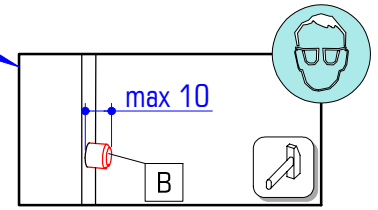
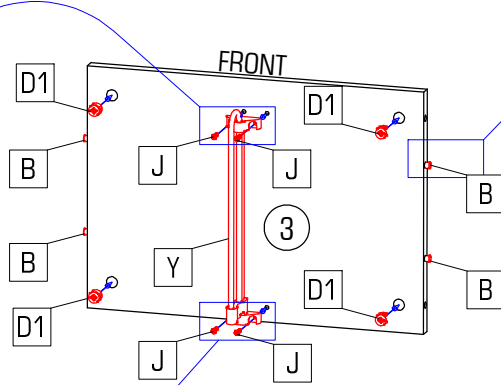
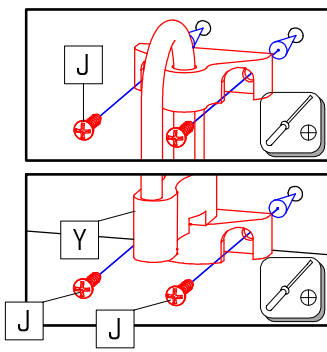
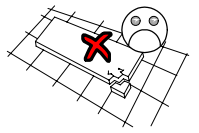
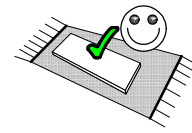

							
B 6x	D1 6x	E 10x	M 4x	Q 8x	S 8x	U 6x	X1 2x



B 10x	D1 10x	E 6x	J 4x	Y 1x



4/10 LEVITO

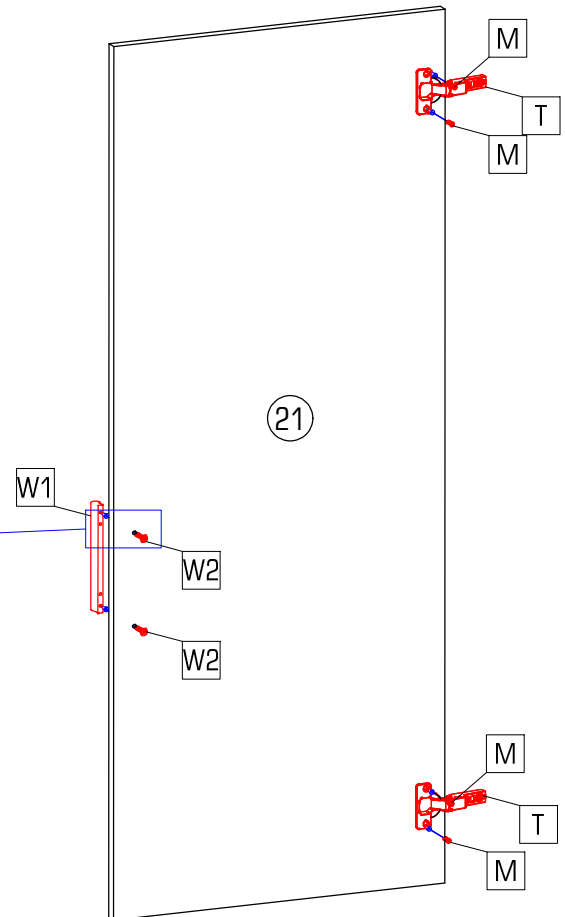
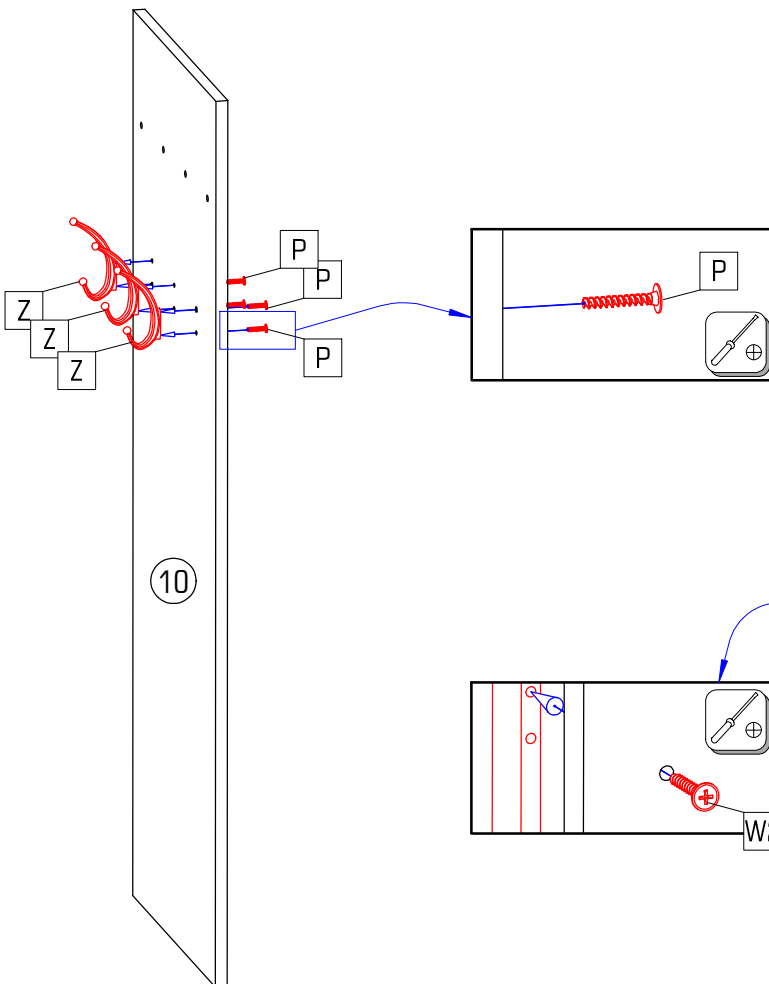
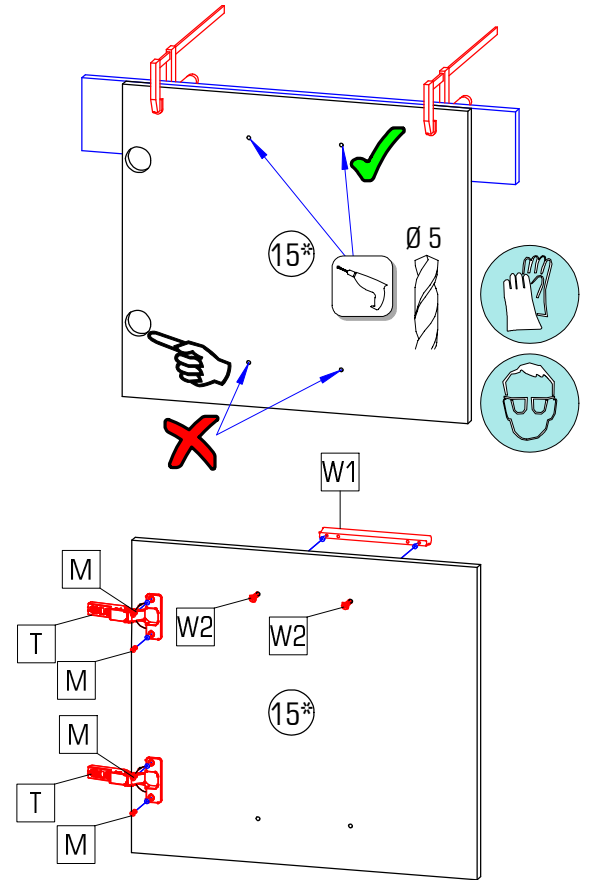
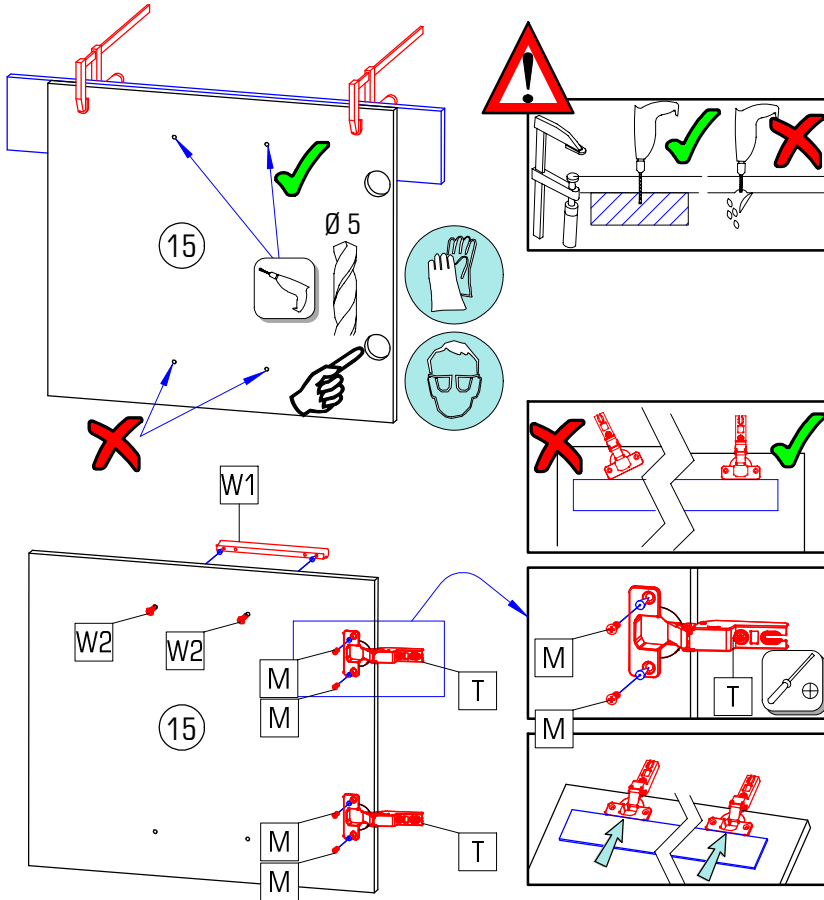
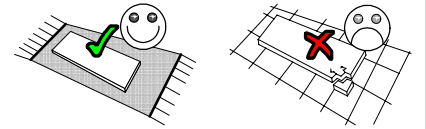

					
Ø3,5x15	Ø4x25		L=148	Ø4x30	
M 12x	P 6x	T 6x	W1 3x	W2 6x	Z 3x



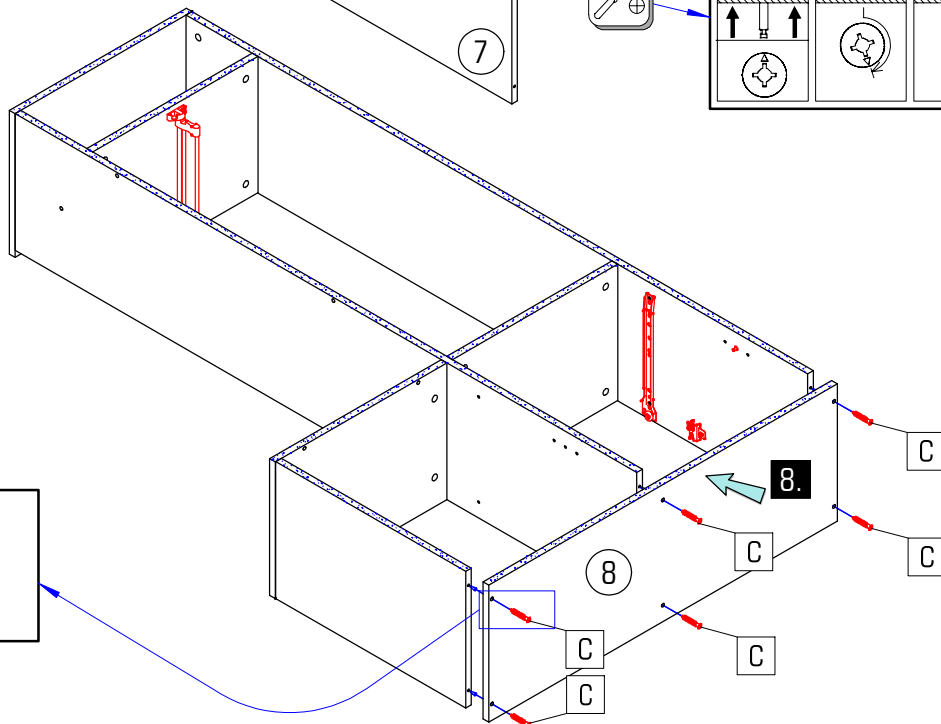
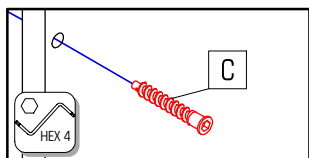
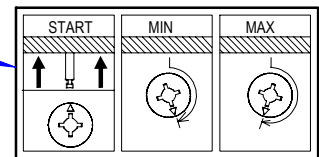
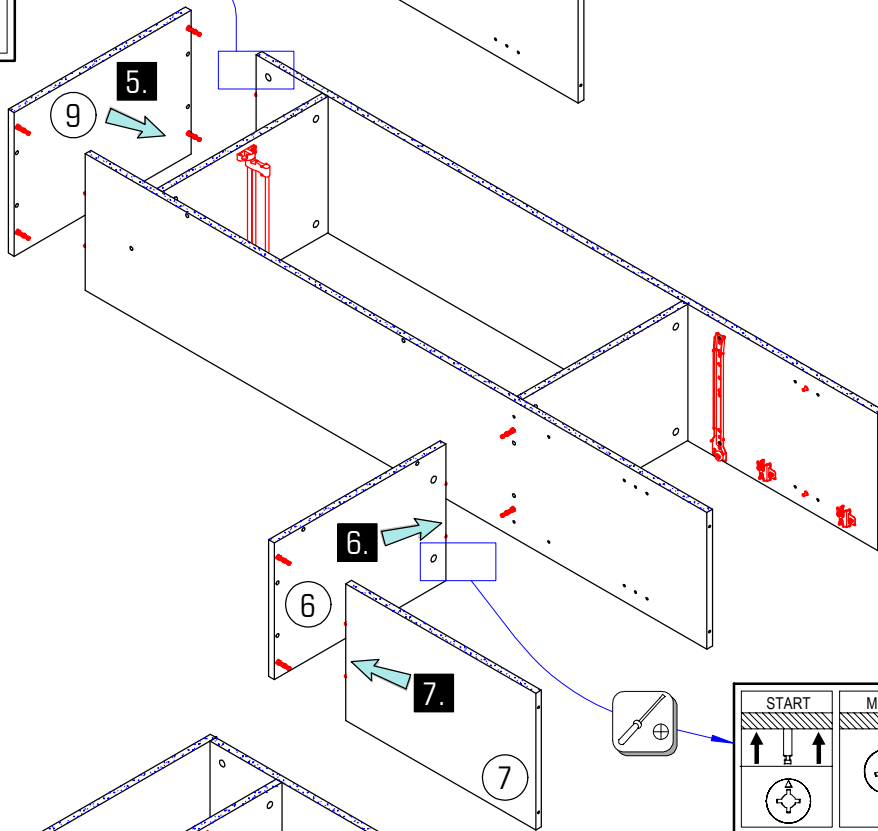
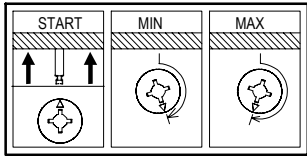
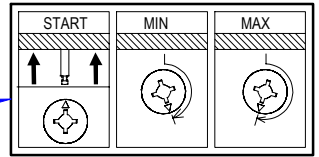
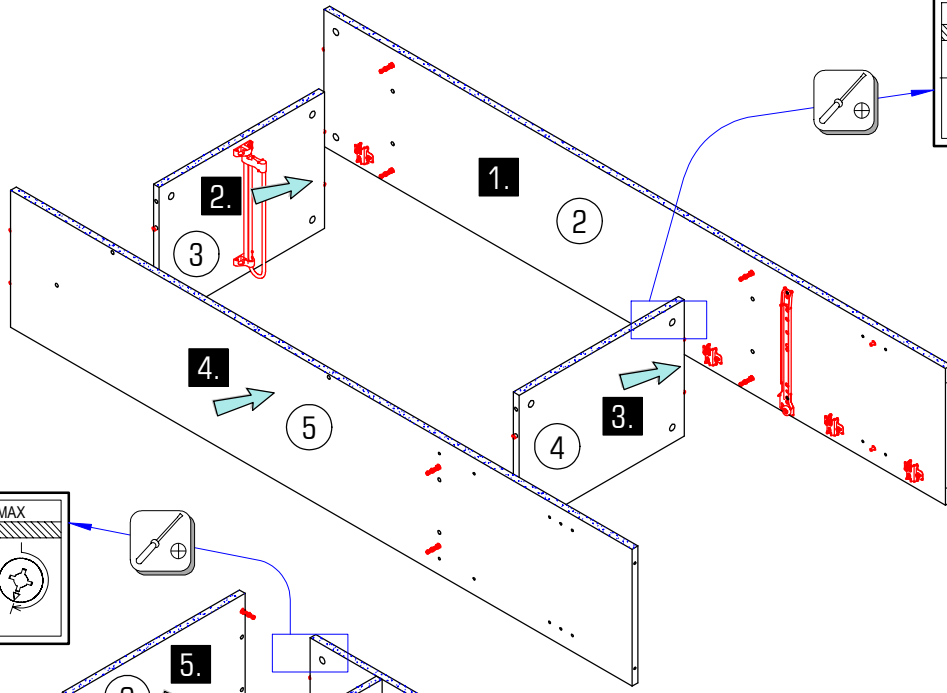
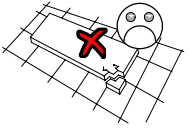
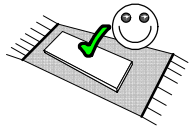



Ø7x50
C 6x



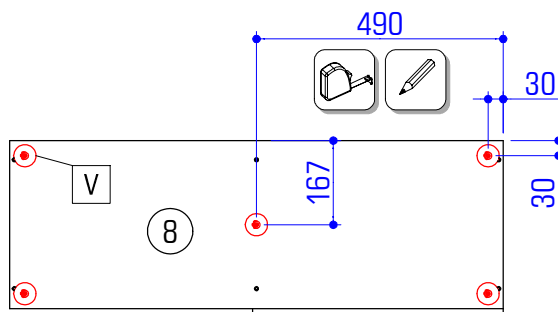
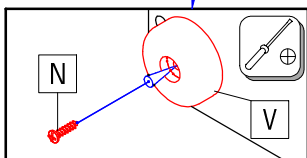
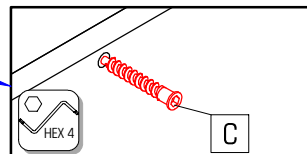
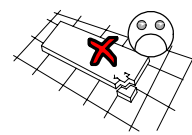
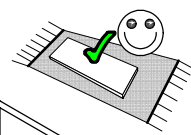
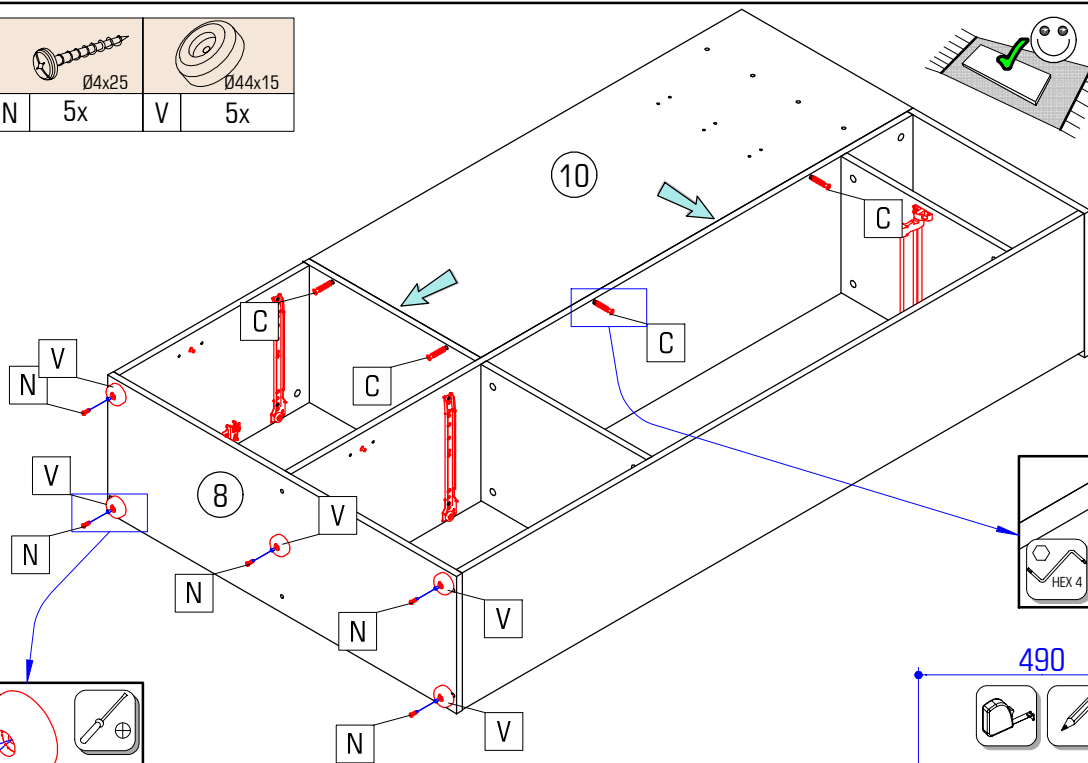

6/10 LEVITO

		
Ø7x50	Ø4x25	Ø44x15
C 9x	N 5x	V 5x

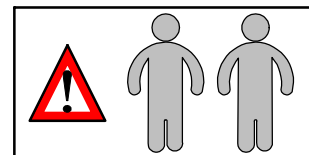
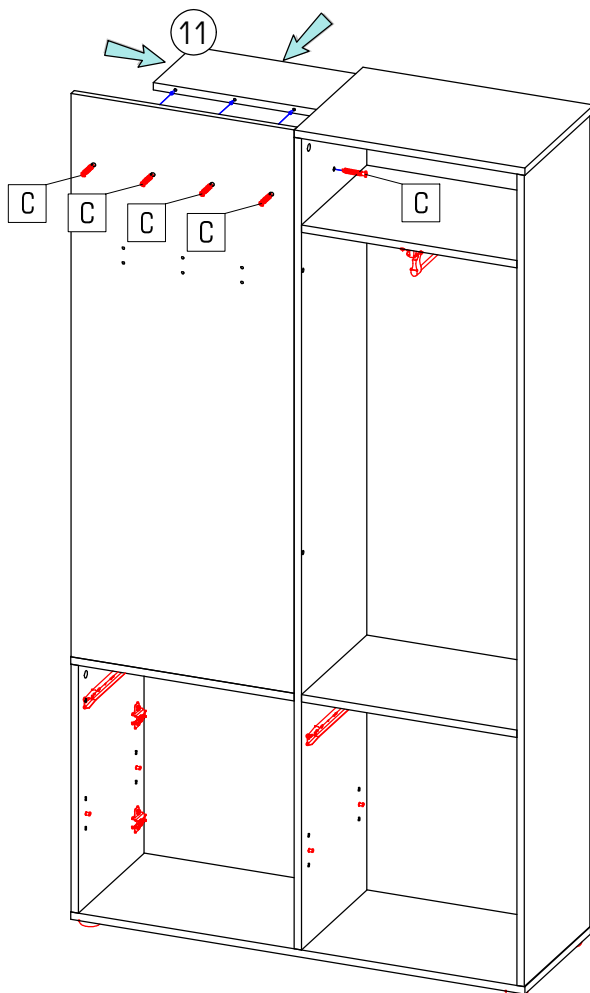

		Ø4x25
	N	5x
		Ø3,5x16
	J	12x

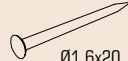
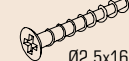

		
Ø1,6x20	Ø2,5x16	3,0
F 50x	G 6x	R 6x

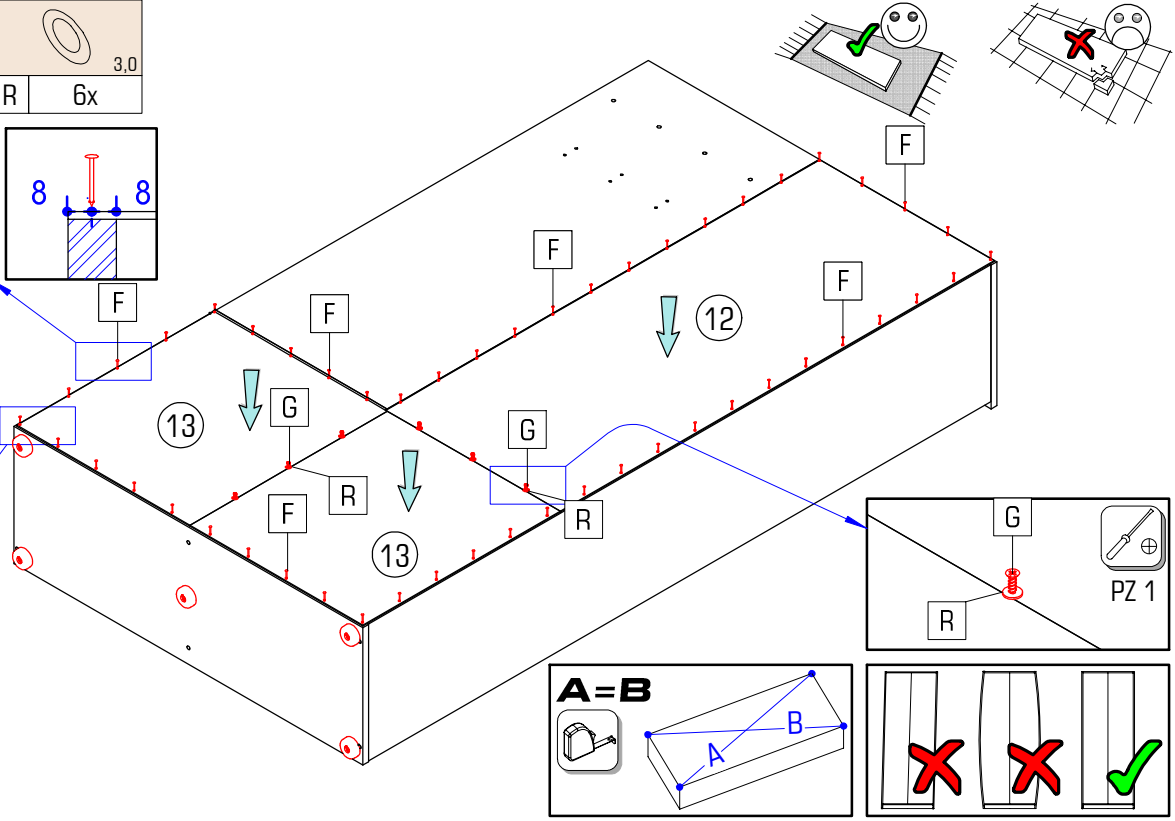

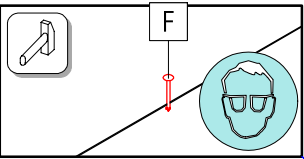

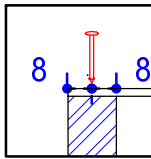

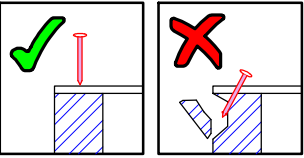

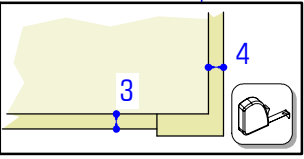

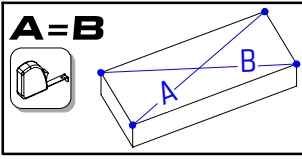

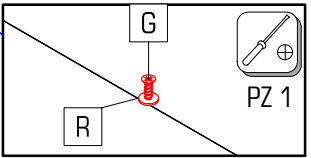

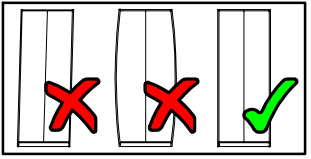



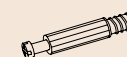



					
Ø7x50	Ø15x13		Ø3,5x16	L=148	Ø4x30
C 8x	D1 8x	E 8x	J 8x	W1 2x	W2 4x

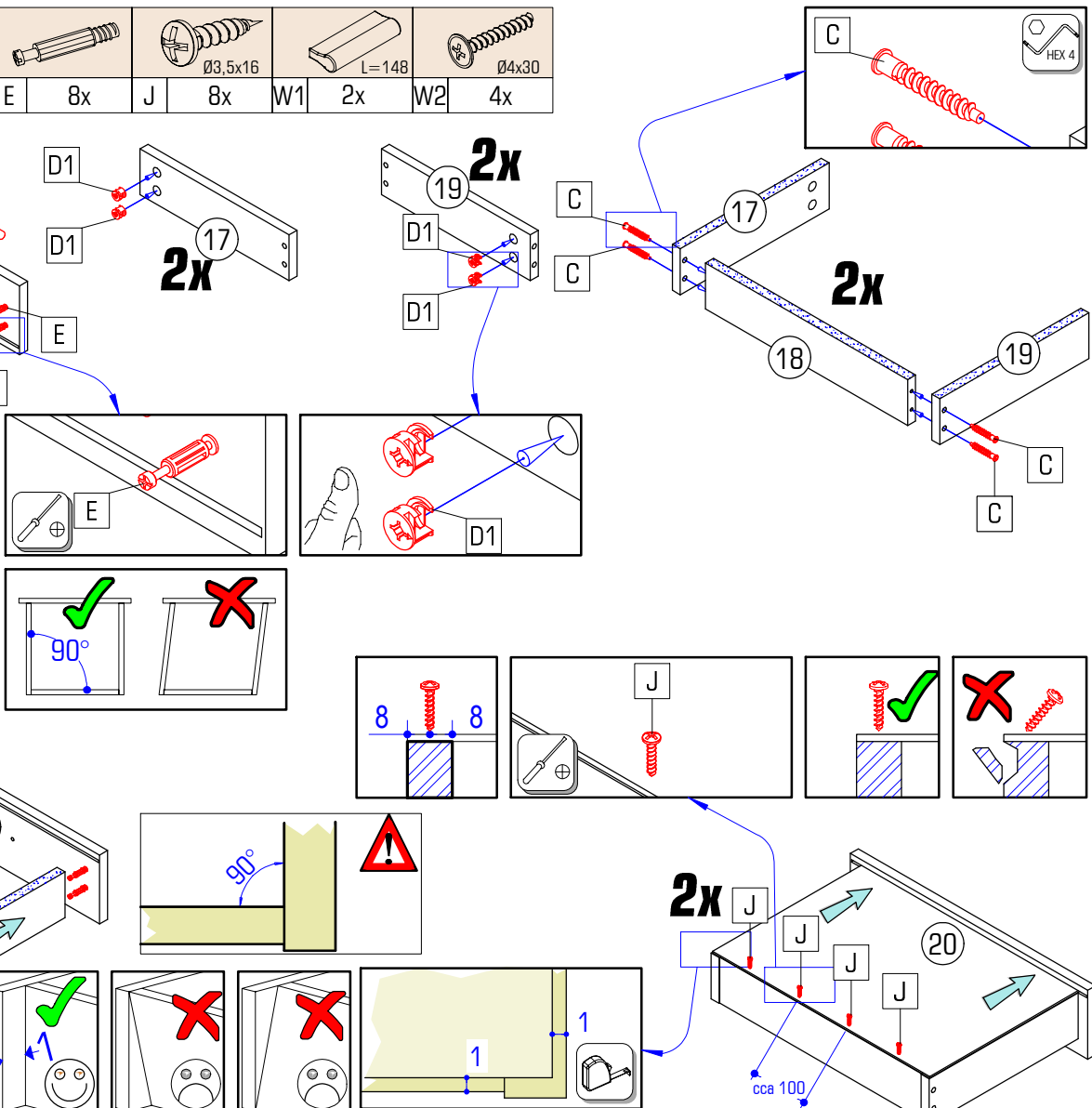

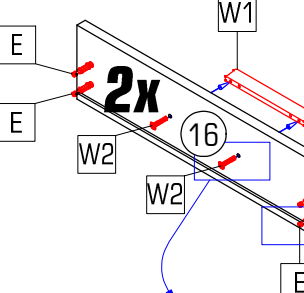

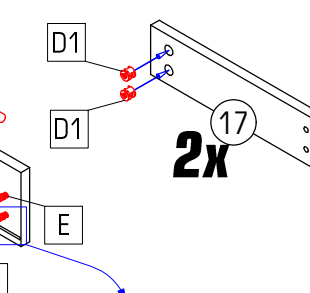

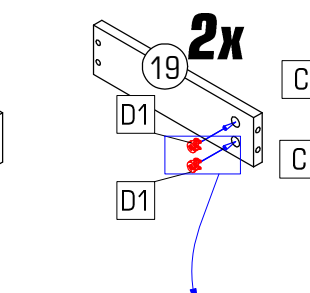

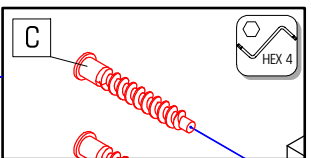

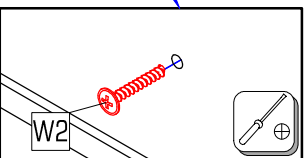

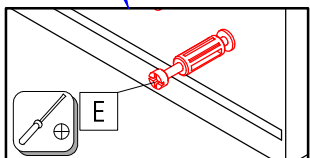

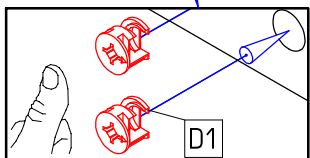

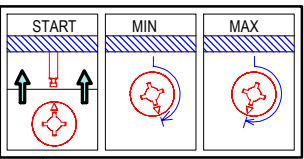

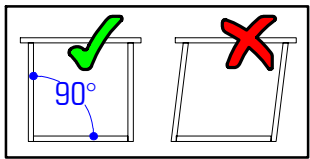

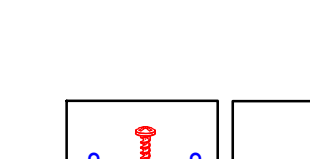

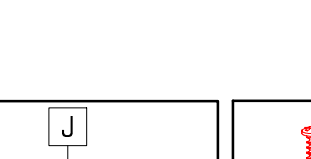

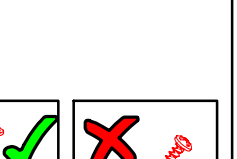

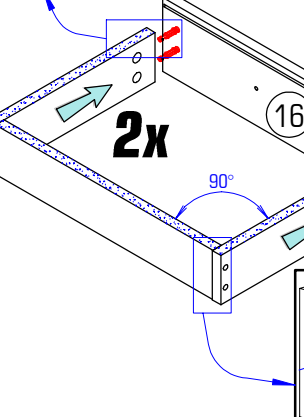

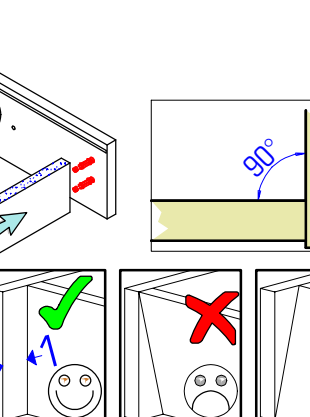

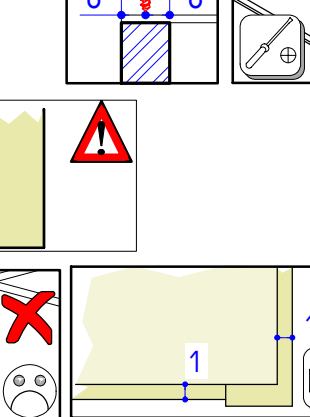

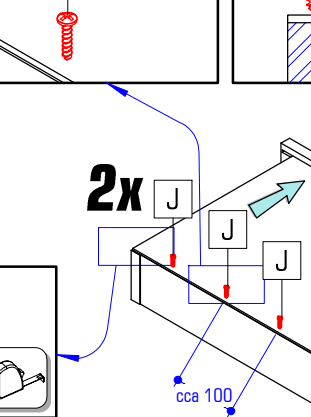

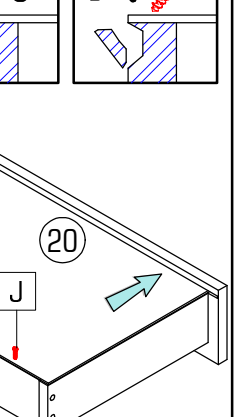

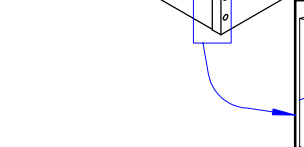

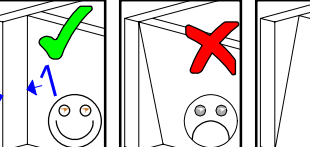

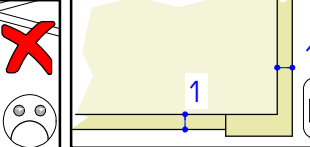

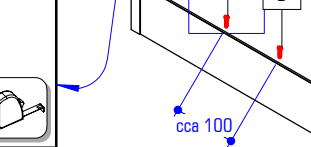

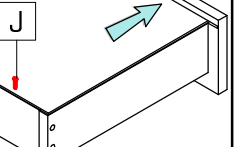





8/10 LEVITO

		
D2	16x	M
		12x
	X2	2x
		L=300

2x

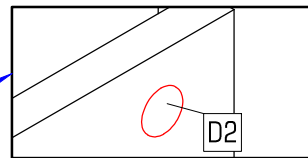
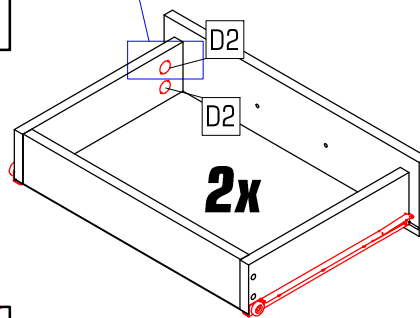
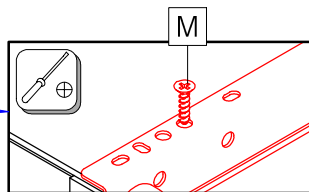
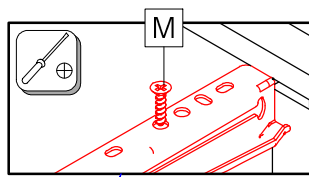
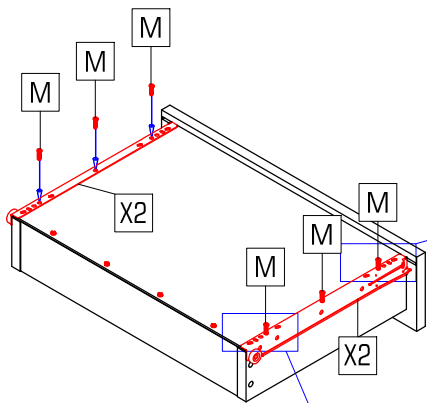

i ± 32 [mm]

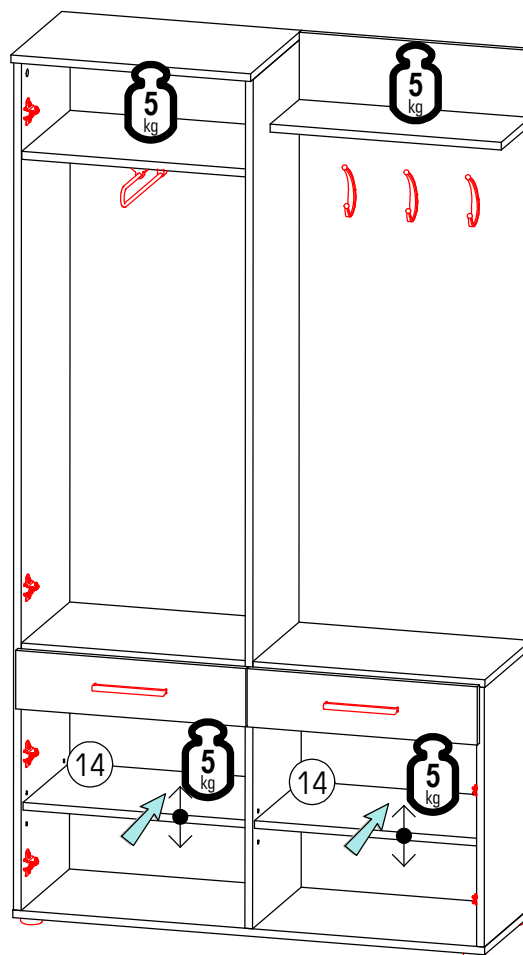
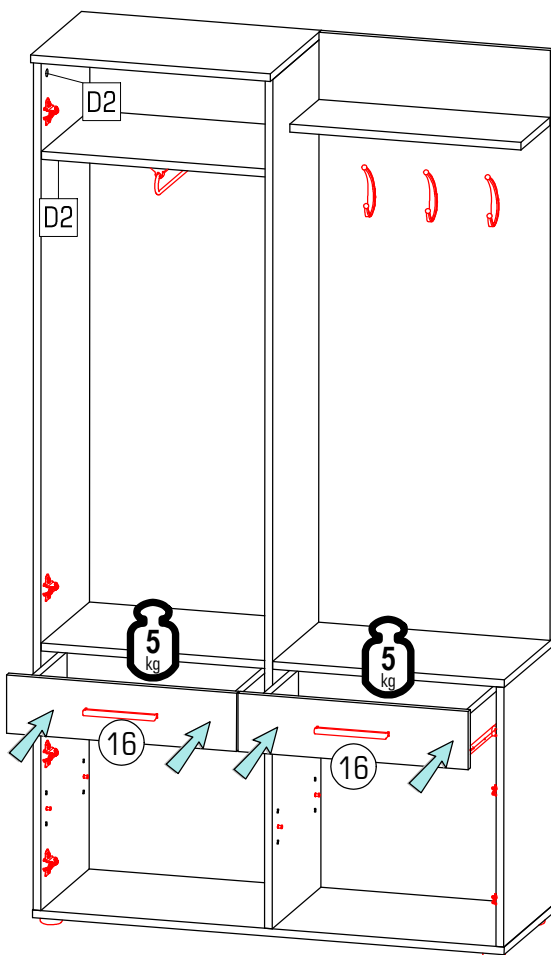

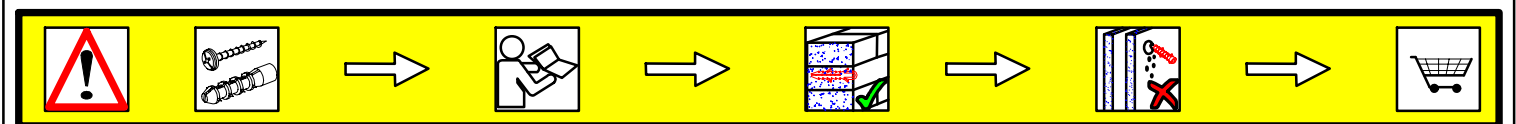
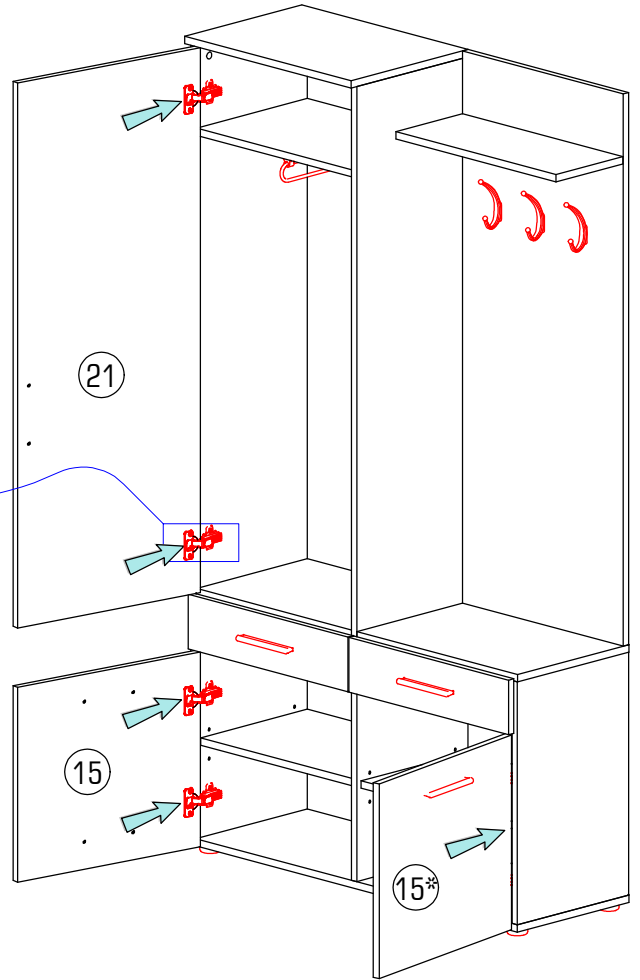
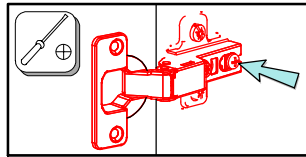
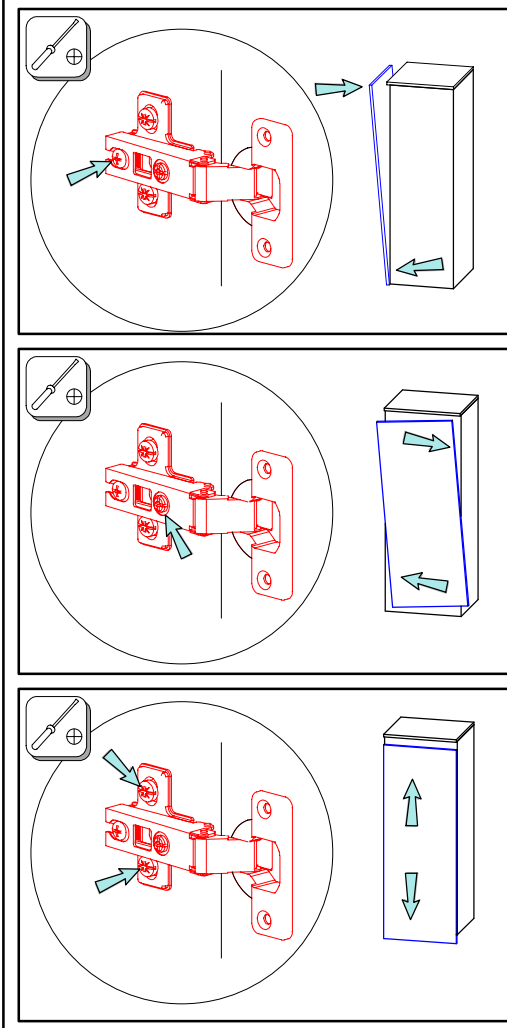

PL Uwaga! Ścianę należy sprawdzić przed montażem. Dołączone uniwersalne kolki rozporowe są odpowiednie tylko do stosowania w mocnych murach, takich jak beton lub cegła. Nie rób za pomocą kolków ozporowych murowanych, takich jak pustak, lekka kostka, powierzchnie takie jak gipsowo-kartonowe lub inne systemy ram. Jeśli dotyczy, muszą to być określone kolki rozporowe być użytym! Są one dostępne w specjalistycznym sklepie niezgodność, producent / sprzedawca lub importer nie ponoszą odpowiedzialności.

RO Prudență! Zidul trebuie examinat înainte de asamblare prizele de perete sunt adecvatenumai pentru utilizarea în zidărie fermă, cum ar fi betonul bloc sau cărămidă. Nu folosiți zidăria zidurilor de perete, cum ar fi cărămida goală, blocul ușor, suprafețe cum ar fi gips-carton sau altă încădrare sisteme. Dacă este cazul, trebuie folosite anumite prize de perete! Acestea sunt disponibile la un magazin specializat (magazin de hardware) . În caz de nerespectare, producătorul / vânzătorul cu amănuntul sau importatorul nu își asumă răspunderea.

SI Pozor! Pred montažo preverite stanje stene. Priloženi univerzalni mozniki so izključno samo za uporabo na čvrstem zidovju, kot sta beton in opeka. Stenski mozniki se ne smejo uporabljati pri zidovju kot so votlino opeke, zidaki za lahko gradnjo, mavčne plošče ali druge okvirne gradnje. Pri teh zidovjih morate v danih primerih uporabljati posebne moznike. Ti so na voljo v specializiranih trgovinah (trgovinah z gradbenim materialom) Pri upoštevanju se s strani proizvajalca/trgovca in uvoznika ne prevzame jamstvo.

DE Achtung! Die Wandbeschaffenheit ist vor der Montage unbedingt zu prüfen. Die beigelegten Universaldübel sind ausschließlich nur zur Verwendung für festes Mauerwerk wie Beton/Ziegel. Die Mauerdübel dürfen nicht bei Mauerwerk wie Hohlraumziegel, Leichtbausteinen, Gipskartonplatte oder anderer Rahmenbauweise verwendet werden. Bei diesen Mauerwerken sind gegebenenfalls Spezialdübel zu verwenden! Diese sind in einem Fachgeschäft erhältlich. Bei Nichteinhaltung wird seitens Produzenten/Händler und Importeur keine Haftung übernommen.

HR Pažnja! Prije montaže obvezno provjerite svojstvo zida. Priložene univerzalne tiplje namijenjene su isključivo za masivne zidove od betona/opeke. Tiplje za masivne zidove ne smiju se koristiti za zidove kao npr šupljina opeka laki sastavni elementi, gips-kartonske ploče ili drugi modularni načini gradnje. Za te zidove potrebne su eventualno specijalne tiplje! Iste su dostupne u specializiranim trgovinama građevinskim materijalom. U slučaju nepridržavanja prethodno navedenih napomena, proizvođač/trgovac i uvoznik ne preuzimaju odgovornost!

HU Vigyázat! Szerelés előtt a fal felületét feltétlenül vizsgálja meg. A mellékelt univerzális tiplje kizárólag stabil falazathoz használható mint például beton/tégla. A fali tiplje nem használható könnyű építőkövekhez, üreg tégla, gipszkarton lapokhoz vagy más fázvas építőanyagokhoz. Ezekhez a fal felületekhez csak speciális tiplik használhatóak, melyek szaküzletében (barkácsruházakban) beszerezhetőek. Fentiek figyelmen kívül hagyása esetén a gyártó/kereskedő vagy forgalmazó nem vállal felelősséget.

EN Caution! The wall must be examined before assembly. The included universal wall plugs are only suitable for using in firm masonry such as concrete block or brick. Do not using the wall plugs masonry such as hollow brick, lightweight block, surfaces such as gypsum plasterboard or other framing systems. If applicable, particular wall plugs must be used! These are available at a specialised store (hardware store). In case of non-compliance, the manufacturer/retailer or importer do not assume liability.

CZ Upozornění! Před montáží je nutné zkontrolovat stav stěny. Priložené univerzální hmoždinky jsou určeny pouze k použití pro pevné zdivo jako beton/cihly. Hmoždinky do zdi se nesmí používat u dutinová cihla, zdiva jako pórovitý stavební kámen, sádrokartonová deska nebo jiný měkký materiál. U těchto zdiv jsou nutné použít speciální hmoždinky! Jsou k dostání v speciálních prodejnách se stavebním materiálem. Při nedodržení těchto pokynů výrobce/prodejce a dovozce neručí za způsobené škody.

SK Upozornenie! Pevnosť steny sa musí pred montážou bezpodmienečne skontrolovať. Priložené univerzálne hmoždenky používajte jedine pre pevné murivo ako je betón/tehla. Hmoždenky sa nesmú používať v prípade ľahkého stavebného muriva, dutá tehla, Sádorkartónová doska, alebo iných konštrukcií rámu. U týchto stien je nutné použiť špeciálne hmoždenky! Tieto je možné dostať v špeciálnych predajniach so stavebným materiálom. Pri nedodržaní pokynov nepreberajú výrobcovia/predajci a dodávateľia zodpovednosť za vzniknuté škody.

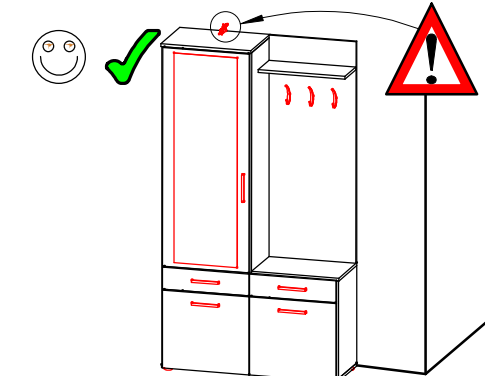

SK	VÝSTRAHA
CZ	VAROVÁNÍ
HR	UPOZORENIE
DE	WARNUNG
HU	FIGYELEM
PL	OSTRZEŻENIE
RO	AVERTIZARE
EN	WARNING
SI	OPOZORILO

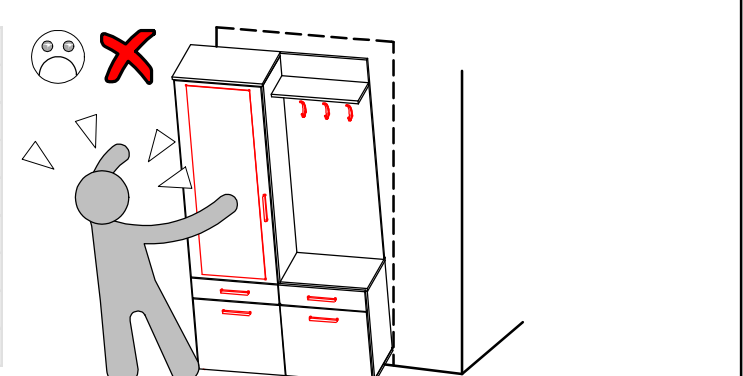

10/10 LEVITO

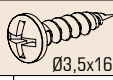
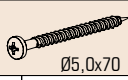
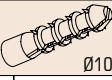
			
H	J	K	L
1x	2x	1x	1x
	Ø3,5x16	Ø5,0x70	Ø10

i

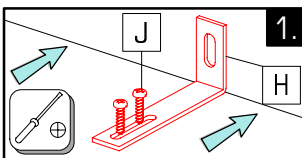

1.

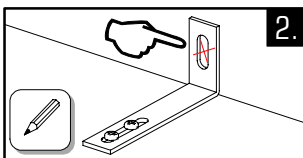

2.

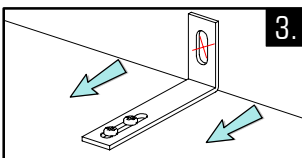

3.

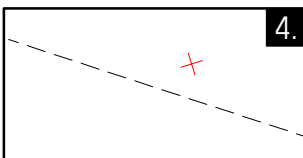

4.

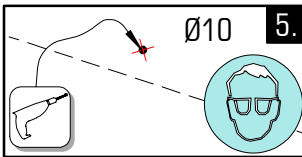

5. Ø10

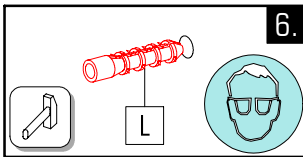

6.

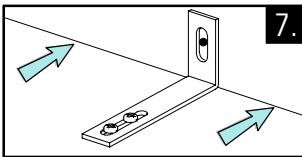

7.

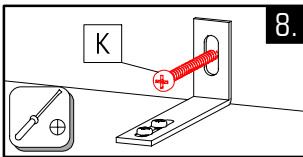

8.

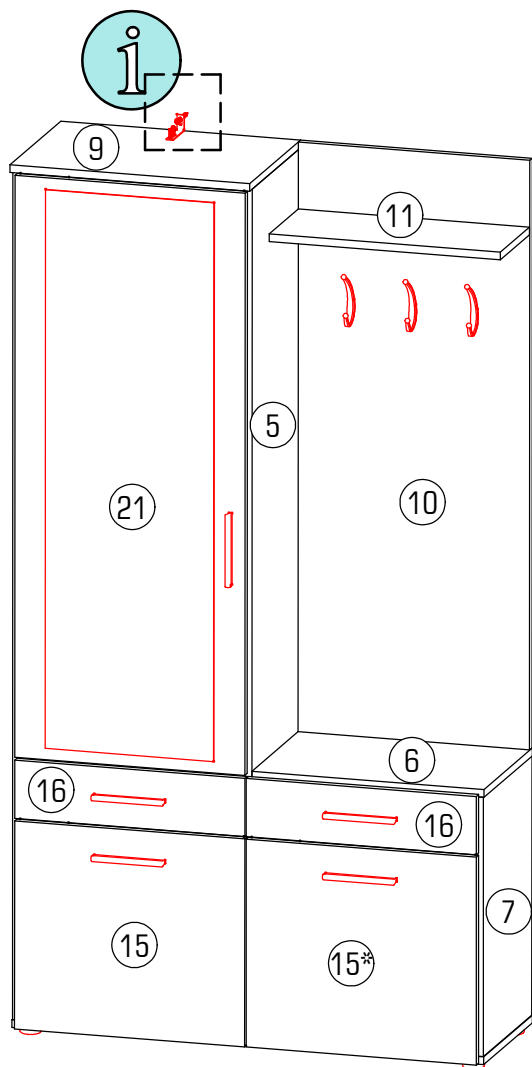
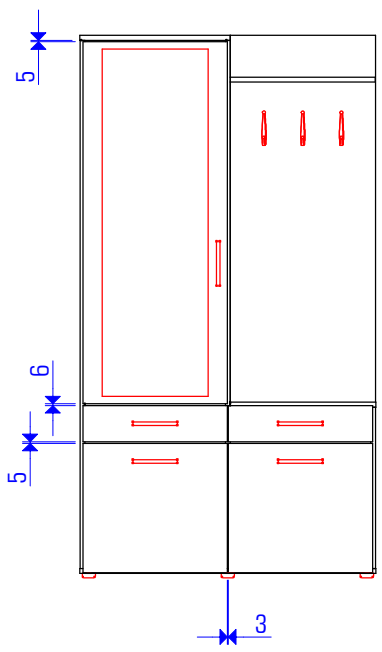
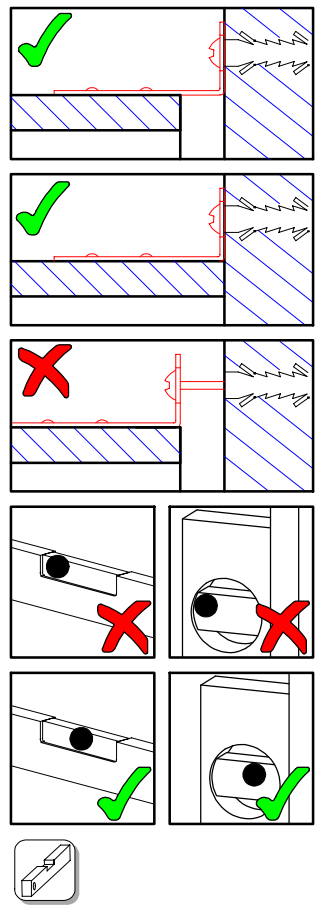
Green checkmarks indicate correct installation. Red X marks indicate incorrect installation (e.g., not flush, not secured properly).

